

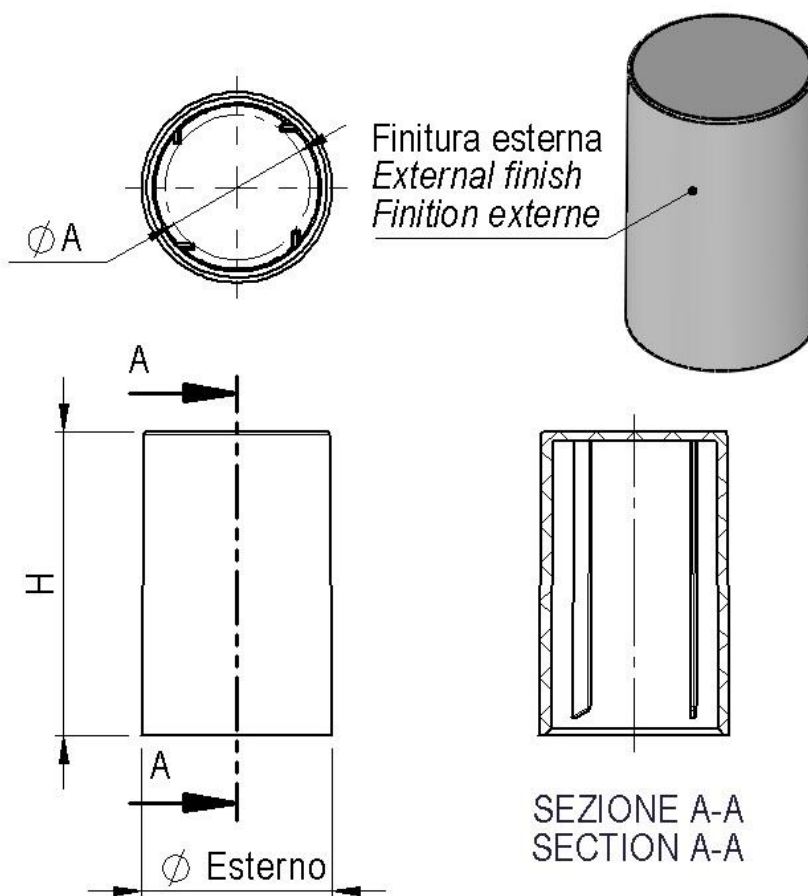





**Art. cod. 00019**
**Descrizione / Description / Description**
**Cappuccio copri-valvola**
**Capsule, valve cover**
**Capsule, couvercle de valve**

**Tabella dati tecnici / Technical data table / Tableau données techniques**

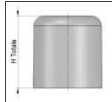
					
$\phi$ Esterno (mm)	Altezza H (mm)	$\phi$ Aggancio A (mm)	Finitura esterna	Materiale	Peso (g)
External $\phi$ (mm)	Height H (mm)	$\phi$ Engagement A (mm)	External finish	Material	Weight (g)
$\phi$ Extérieur (mm)	Hauteur H (mm)	$\phi$ D'engagement A (mm)	Finition externe	Matière	Poids (g)
22,45	35,8	17,1	Lucida/Glossy/ Brillante		3,16 ±0,1

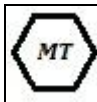
Il peso indicato è puramente indicativo e non valido ai fini CONAI.

The weight indicated is purely indicative.

Le poids indiqué est indicatif.

## Tabella dati imballaggio-spedizione / Table packing and shipping details / Table données d'emballage-expédition

Scatola standard (cm)	Sacchetto	Quantità per scatola	Quantità per pallet	Pallet (cm)
<i>Standard box (cm)</i>	<i>Bag</i>	<i>Pcs box</i>	<i>Pcs pallet</i>	<i>Pallet (cm)</i>
<i>Carton standard (cm)</i>	<i>Sachet</i>	<i>Pcs carton</i>	<i>Pcs palette</i>	<i>Palette (cm)</i>
60x40 H:33,5	PE Food contact	2800	33600	120x80 H:112

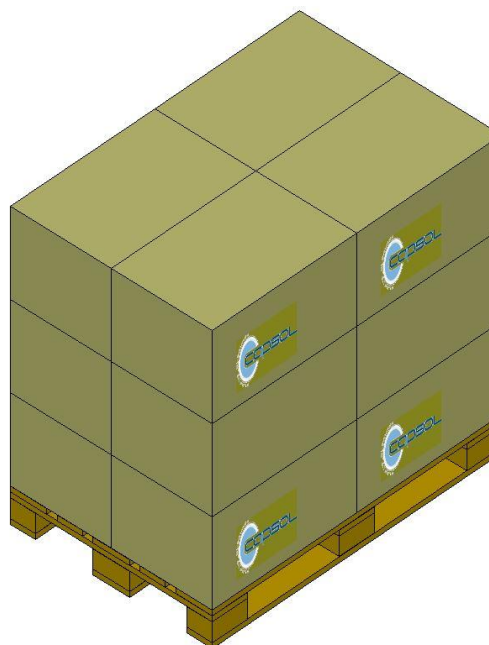

### Stoccaggio / Storage / Stockage

Conservare i prodotti nella loro confezione originale in un luogo pulito, fresco e asciutto.  
*Store the products in their original packaging in a clean, cool and dry place.*  
*Stocker les produits dans leur emballage d'origine dans un endroit propre, frais et sec.*

Temperatura / Temperature / Temperature : **5±30°C**

Umidità / Humidity / Humidité : **45÷75%**

Conservare i prodotti a temperatura ambiente (**20°C±5**) per **48 ore** prima dell'uso sulla macchina confezionatrice.  
*Store the products at room temperature (20°C±5) for 48H before using on packaging machine.*  
*Stocker les produits à température ambiante (20°C±5) pendant 48 heures avant l'utilisation sur la machine d'emballage.*