

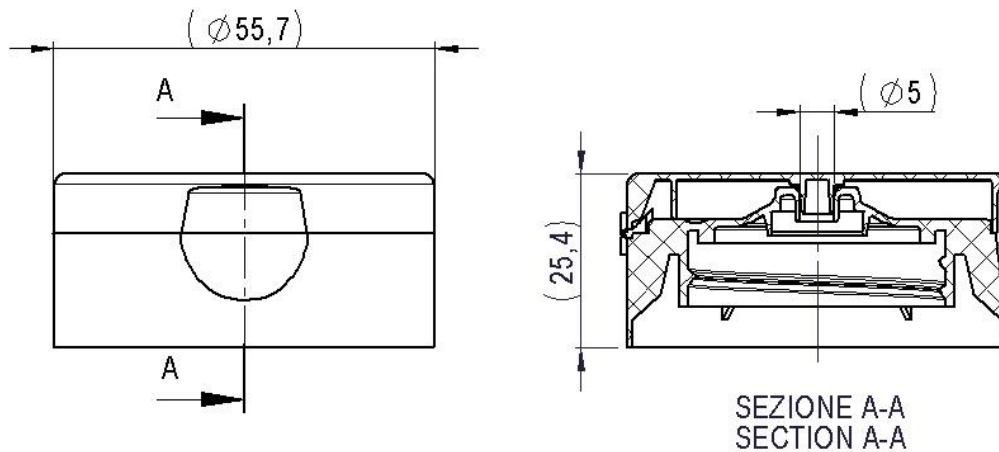

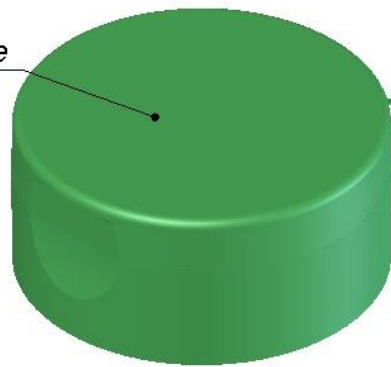





Art. cod. 00823

**Descrizione / Description / Description**  
**FLIP-TOP  $\varnothing 55-38/400$  foro erogazione  $\varnothing 5$**   
**FLIP-TOP  $\varnothing 55-38/400$  delivery hole  $\varnothing 5$**   
**FLIP-TOP  $\varnothing 55-38/400$  trou de livraison  $\varnothing 5$**



Finitura esterna satinata  
 Satin exterior finish  
 Finition satinée externe

**Tabella dati tecnici / Technical data table / Tableau données techniques**

 Tipo filetto Thread type Type filet	 Passo filetto (mm) Thread pitch (mm) Pass de filet (mm)	 N° Principi filetto N° Thread starts N° Pass de vis filet	 Sigillo di garanzia Tamper evident Inviolabilité	 Materiale Material Matière	 Peso (g) Weight (g) Poids (g)
38/400	-	-	No/no/non		11,0 $\pm$ 0,50

Il peso indicato è puramente indicativo e non valido ai fini CONAI.

The weight indicated is purely indicative.

Le poids indiqué est indicatif.

## Tabella dati imballaggio-spedizione / Table packing and shipping details / Table données d'emballage-expédition

Scatola standard (cm)	Sacchetto	Quantità per scatola	Quantità per pallet	Pallet (cm)
<i>Standard box (cm)</i>	<i>Bag</i>	<i>Pcs box</i>	<i>Pcs pallet</i>	<i>Pallet (cm)</i>
<i>Carton standard (cm)</i>	<i>Sachet</i>	<i>Pcs carton</i>	<i>Pcs palette</i>	<i>Palette (cm)</i>
60x40 H:33,5	PE Food contact	700	8400	120x80 H:112



### Stoccaggio / Storage / Stockage

Conservare i prodotti nella loro confezione originale in un luogo pulito, fresco e asciutto.

*Store the products in their original packaging in a clean, cool and dry place.*

*Stocker les produits dans leur emballage d'origine dans un endroit propre, frais et sec.*

Temperatura / Temperature / Temperature : **5÷30°C**

Umidità / Humidity / Umidité : **45÷75%**

Conservare i prodotti a temperatura ambiente (**20°C±5**) per **48 ore** prima dell'uso sulla macchina confezionatrice.

*Store the products at room temperature (20°C±5) for 48H before using on packaging machine.*

*Stocker les produits à température ambiante (20°C±5) pendant 48 heures avant l'utilisation sur la machine d'emballage.*