

Art. cod. 01123







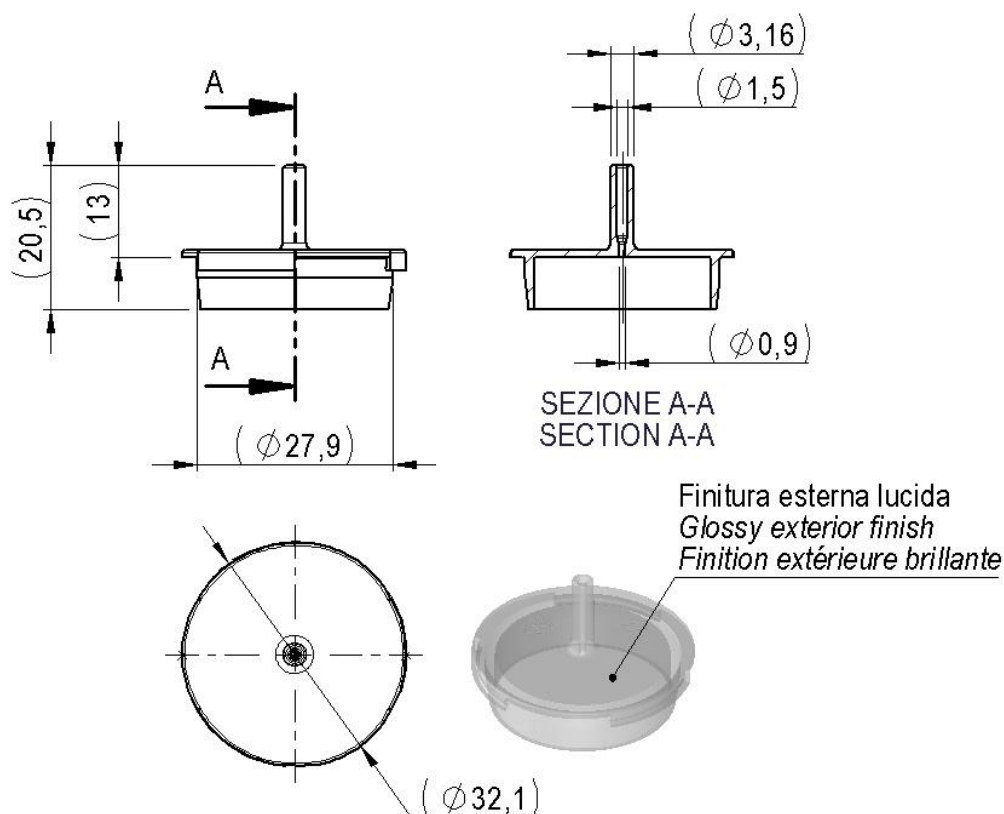

Descrizione / Description / Description

Contagocce PFP35 Puma

PFP35 Dropper Puma

Compte-gouttes Puma PFP35

Tabella dati tecnici / Technical data table / Tableau données techniques

							
∅ Esterno (mm)	∅ Aggancio a flacone (mm)	∅ Esterno punta (mm)	∅ Erogazione (mm)	H - Totale (mm)	Hp - Parziale (mm)	Materiale	Peso (g)
∅ External (mm)	∅ Bottle engagement (mm)	∅ Outer tip (mm)	∅ Delivery (mm)	H - Total (mm)	Hp - Partial (mm)	Material	Weight (g)
∅ Externe (mm)	Engagement de bouteille ∅ (mm)	∅ Pointe extérieure (mm)	∅ Livraison (mm)	H - Total (mm)	Hp - Partiel (mm)	Matière	Poids (g)
∅32,10	∅27,9	∅3,16	∅1,50	20,50	13,00		1,45 ±0,10

Il peso indicato è puramente indicativo e non valido ai fini CONAI.

The weight indicated is purely indicative.

Le poids indiqué est indicatif.

Tabella dati imballaggio-spedizione / Table packing and shipping details / Table données d'emballage-expédition

Scatola standard (cm)	Sacchetto	Quantità per scatola	Quantità per pallet	Pallet (cm)
Standard box (cm)	Bag	Pcs box	Pcs pallet	Pallet (cm)
Carton standard (cm)	Sachet	Pcs carton	Pcs palette	Palette (cm)
60x40 H:33,5	PE Food contact	4000	48000	120x80 H:112

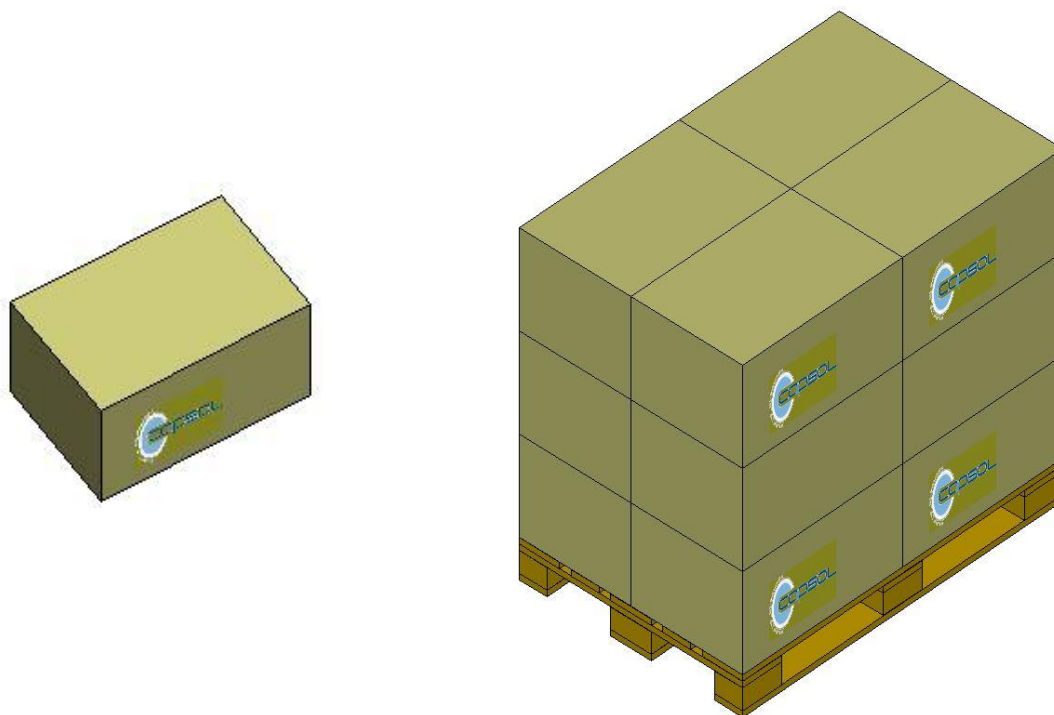

Stoccaggio / Storage / Stockage

Conservare i prodotti nella loro confezione originale in un luogo pulito, fresco e asciutto.
Store the products in their original packaging in a clean, cool and dry place.
Stocker les produits dans leur emballage d'origine dans un endroit propre, frais et sec.

Temperatura / Temperature / Temperature : **5÷30°C**

Umidità / Umidity / Umidité : **45÷75%**

Conservare i prodotti a temperatura ambiente (**20°C±5**) per **48 ore** prima dell'uso sulla macchina confezionatrice.
Store the products at room temperature (20°C±5) for 48H before using on packaging machine.
Stocker les produits à température ambiante (20°C±5) pendant 48 heures avant l'utilisation sur la machine d'emballage.